

dyson purifier humidify+cool

Dyson purifier humidify plus cool

User manual

SV12 JN.00000 PN.000000-00-00
00.00.00 VERSION NO.01

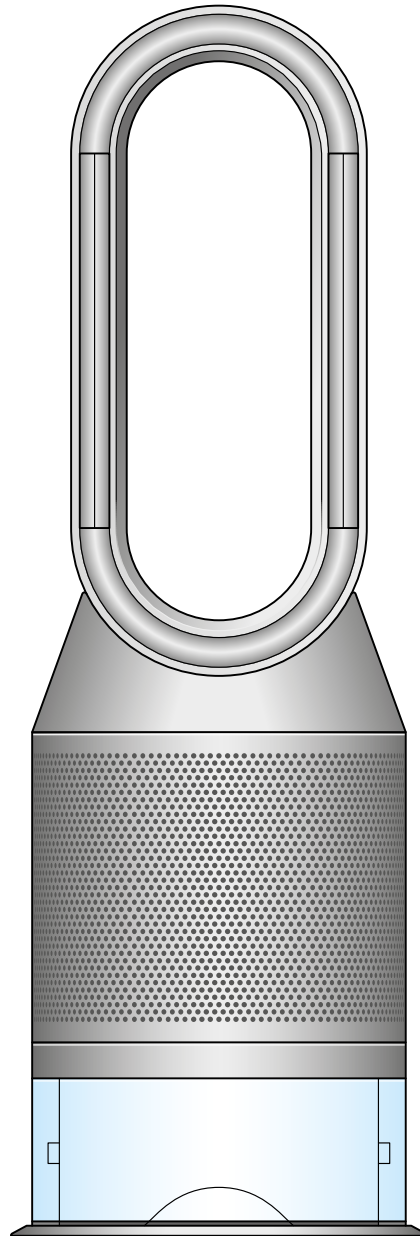

Getting started

Assembling your machine

Connecting to the Dyson Link app

Filling the water tank

Power and continuous monitoring

Information menu

Auto purify mode

Auto humidify mode

Oscillation

Airflow speed and direction

Sleep timer

Night mode

Deep cleaning your machine

Changing your HEPA+Carbon filter

Looking after your machine

Alerts

Getting started

Image of the machine with the location of parts labelled.

The top, of the two buttons located on the main body of the machine just below the loop amplifier, is the Deep clean cycle button.

Deep clean cycle button

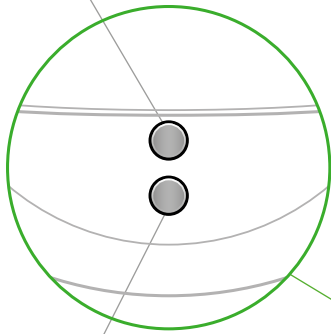

Stand-by button

Below the Deep clean cycle button is the standby button.

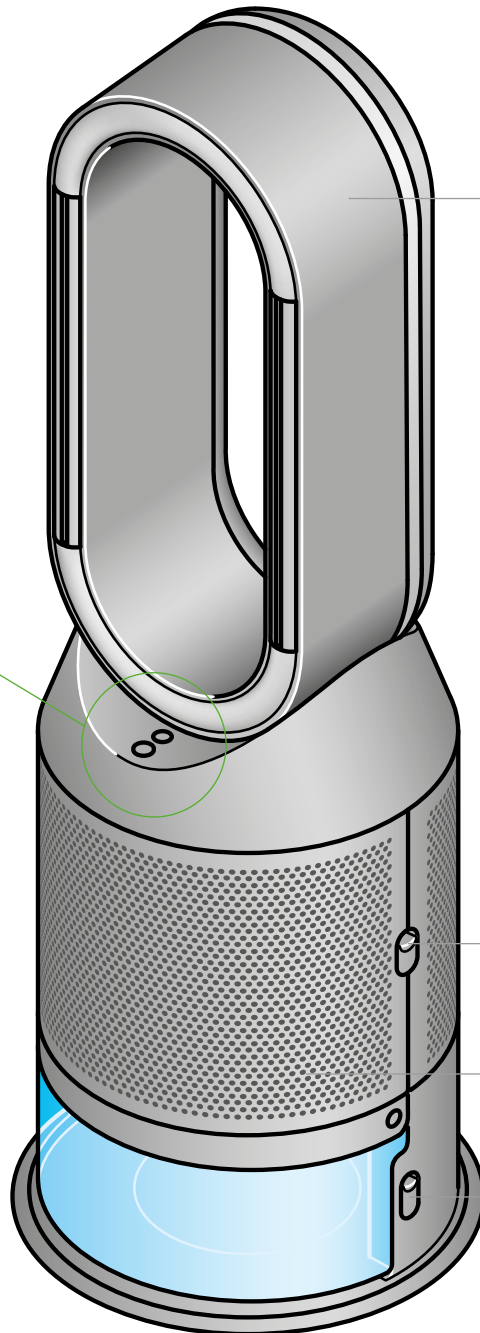

Amplifier loop

The large oval loop making up the top of the machine.

Outer cover release buttons

Two push down buttons located either side of the main body of the machine.

Outer cover

The mesh cover on the bottom of the machine is in two parts, front and back.

Water tank release buttons

The buttons to remove the water tank are located on both sides, just above the bottom of the machine.

The layout of the remote control with the standby button on the top left, the Auto purify mode button below, then the Airflow speed toggle up and down button. Below that is the Oscillation button and finally at the bottom is the Sleep timer button. On the top right-hand side is the Information menu button, then going downwards, the Auto humidify mode button, humidity control toggle button, Airflow direction and then Night mode button at the bottom.

Stand-by

Auto purify mode

Airflow speed

Oscillation

Sleep timer



Information menu

Auto humidify mode

Humidity control

Airflow direction

Night mode

Assembling your machine

Use both hands to lift your machine out of the box, by its base.

Do not lift out by the loop amplifier.

Assemble your machine with the filters that are supplied.

Your machine comes with a HEPA+Carbon filter. If you purchased the Dyson Purifier Humidify+Cool Formaldehyde™ your machine also comes with a permanent catalytic filter.

Push the HEPA+Carbon filter into the outer cover and position on the base. Push firmly until both outer covers click into place.

Place the remote control on top of the machine with the buttons facing down.

Plug in and switch on.

The purifying humidifying fan with the filter covers open showing a HEPA plus carbon filter located in the filter covers and a catalytic filter. Arrows demonstrate that the catalytic filter is fitted directly to the base of the machine and the filter covers will need to be assembled onto the base of the machine.

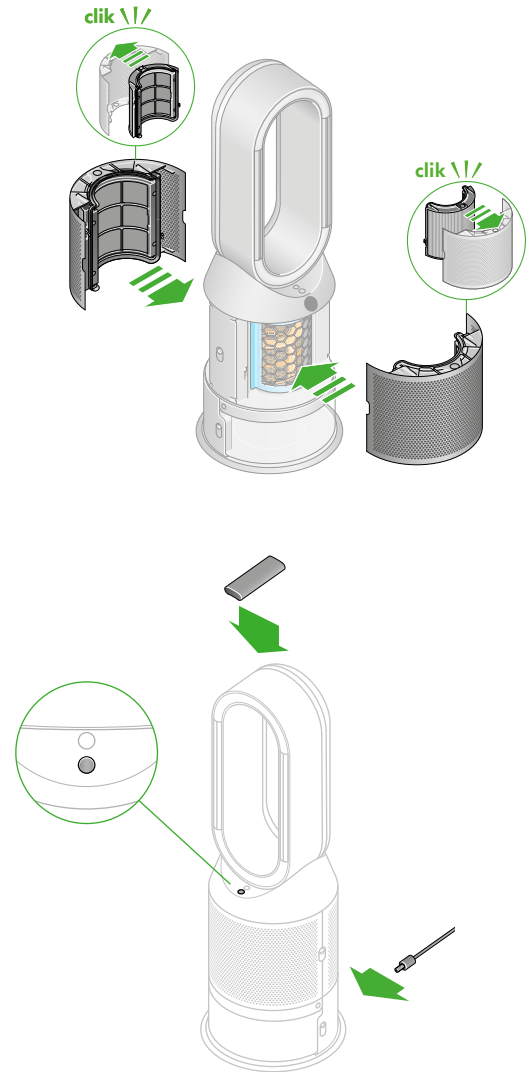

Connecting to the Dyson Link app

Take full control with the Dyson Link app and access step-by-step set up and support, control how and when your Dyson purifying fan operates, monitor air quality with visual updates and automatically keep up to date with the latest software updates.

Download the Dyson Link app from the App Store or Google Play.
Open the app and follow the on-screen instructions to create a new account.

Apple and the Apple logo are trademarks of Apple Inc., registered in the U.S. and other countries.
App Store is a service mark of Apple Inc., registered in the U.S. and other countries.
Google Play and the Google Play logo are trademarks of Google Inc.



Filling the water tank

Before you remove the water tank, make sure humidification modes are turned off and the water tank is empty.

Keep the cap dry

Keep the cap on the water tank dry when you run a Deep clean cycle or fill the tank. It contains power connections and should not be washed. If wet, wipe thoroughly with a dry cloth. Make sure the cap and connections are completely dry before refitting.

Remove the tank

Push down the Water tank release buttons on the sides of your machine.

Slide the water tank out of your machine.

Carry the water tank by its handle to the tap, and unclip the cap.

The water tank cap has two lips either side that can be pulled upwards to release the cap.

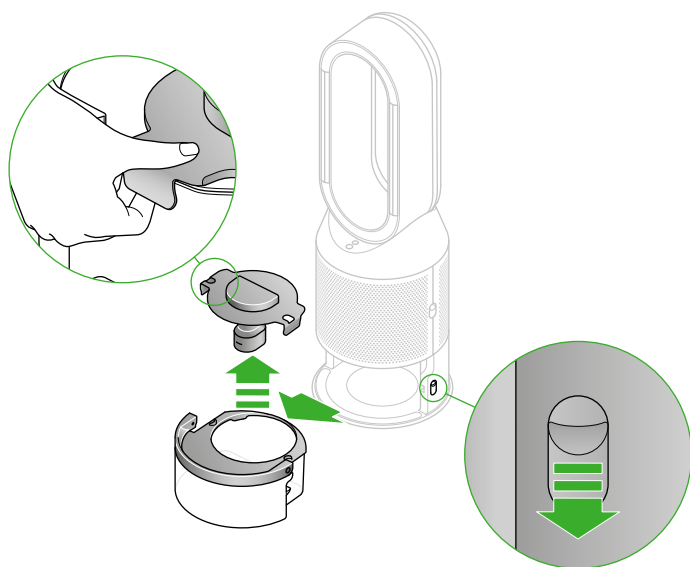

Fill the tank

Fill the water tank to the Max level with cold tap water.

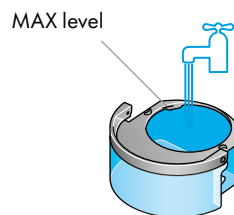

Replace the tank

Replace the cap and secure the cap clips in place.

Make sure the cap is completely dry. If wet, wipe thoroughly with a dry cloth.

Slide the water tank back into your machine until it clicks securely in place.

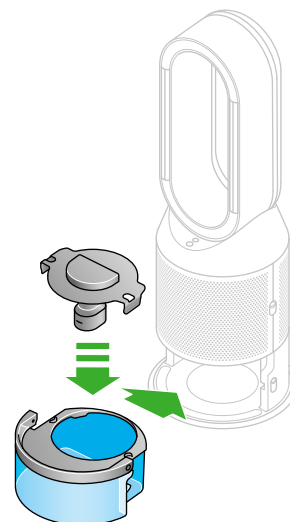

Power and continuous monitoring

Stand-by on/off

Press the Standby on/off button on your Dyson purifier humidifier fan or remote control to stop your machine. It will continue to monitor the air quality.

Continuous monitoring

Continuous monitoring is turned off by default. Once turned on, it will always be active until you turn it off again.

With continuous monitoring turned on, your Dyson purifier humidifier fan will gather air quality, temperature and humidity information, which is displayed on the LCD screen and in the Dyson Link app.

Continuous monitoring on/off

Press and hold the Auto mode button on the remote control for 5 seconds to turn it on. The LCD screen will indicate when continuous monitoring is on or off.

Wi-Fi Connectivity

Wi-Fi is on by default. To turn the Wi-Fi on or off, press and hold the Stand-by on/off button on your machine for 5 seconds.

Information menu

Press this button to scroll through the information being monitored by your Dyson purifying humidifying fan.

Information about air quality, temperature, humidity, Filter and evaporator levels are shown.

When a particular type of pollutant causes air quality to decrease, an icon for the pollutant will show on the LCD screen.



The remote control with the information button on the top right.

Indoor air quality - 12 seconds

Monitor the current air quality with a graph showing the last 12 seconds of data.



Particulate matter (PM10)

Larger microscopic particles up to 10 microns in size, suspended in the air we breathe. These include dust, mold and pollen.



Indoor temperature

Monitor the ambient temperature to help maintain a comfortable environment.



Indoor air quality - 24hrs

Monitor the current air quality with a graph showing the last 24 hours of data.



Nitrogen dioxide and other oxidizing gases

These potentially harmful gases are released into the air by combustion, for example, the burning gas when cooking and in vehicle exhaust emissions.



Filters

The remaining filter life is shown on the LCD screen and will indicate when your filters need replacing.



Indoor humidity

The amount of water vapor in the air, shown as a percentage.



Evaporator

The status will show how full the evaporator is with mineral build-up and how soon a deep clean cycle is required.



Particulate matter (PM2.5)

Microscopic particles up to 2.5 microns in size, suspended in the air we breathe. These include smoke, bacteria and allergens.



Wi-Fi

The current status of connection to the Wi-Fi network.



Volatile organic compounds

VOCs are typically odors that may be potentially harmful. These can be found in cleaning products, paints and furnishings.



Auto purify mode

Set your Dyson purifying humidifying fan to Auto purify mode and the on-board sensors will intelligently adjust the settings of your machine according to the air quality.

Air quality: your machine will pause when the target air quality has been reached, switching on again when the air quality levels drop.

Airflow speed: the airflow speed will increase until the target air quality and temperature have been reached.

Night mode: your machine will only run with airflow speeds from 1 to 4.

The remote control with the Auto purify button on the left hand side, below the Standby button.



Auto humidify mode

Set your Dyson purifying humidifying fan to Auto humidify mode and the on-board sensors will intelligently adjust the settings of the machine according to the temperature and humidity of your room.

Room humidity: your machine will pause when the target room humidity has been reached, switching on again when the room humidity levels drop.

Airflow speed: the airflow speed will increase until the target humidity level has been reached.

To turn off Auto humidify mode or to change the humidity levels manually, press the Humidity control button.

The remote control with the Auto humidify button on the right hand side, below the Information button.

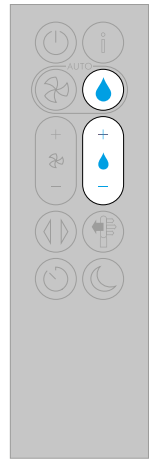

Oscillation

Press the Oscillation button and select the angle of oscillation to 0°, 45°, 90° or Breeze mode.

Pause the oscillation at any point by pressing the Oscillation button.

Press the Oscillation button again to resume.

To reset the Oscillation direction to the center, press and hold the Oscillation button for two seconds.

The remote control with the oscillation button on the left above the sleep timer.



Airflow speed and direction

Press the Airflow speed button to increase and decrease the airflow speed.

Press the Airflow direction button to change the direction of airflow from front to back.

Change the airflow direction for your personal comfort.

Select the Airflow direction to Fan mode for airflow from the front for purifying and cooling.

Set the Airflow direction to Backwards airflow mode, for airflow from the back for purifying without cool air.

Your machine will continue to purify and humidify (if selected) in both Fan and Backwards airflow mode.

Use your Dyson Link app to personalize your settings for Airflow speed and direction.

The remote control with the Airflow speed toggle button on the left hand side, below the Auto purify button. The Airflow direction button is on the right above the Night mode button.

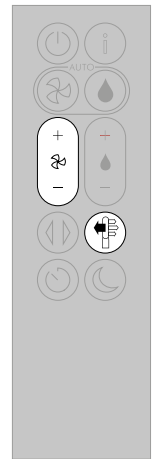

Sleep timer

Your Dyson purifying humidifying fan will turn off automatically after the selected amount of time.

To set the time: press the button to scroll through the time options. Once activated, press the Sleep timer button once to see the time selected.

To cancel the Sleep timer: press the Sleep timer button to scroll through all the options and select the cancel option.

The remote control with the sleep timer button on the bottom left.

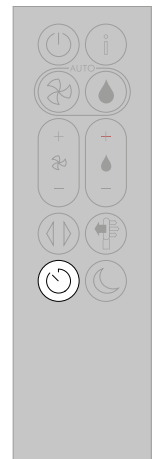

Night mode

In Night mode, your Dyson purifying humidifying fan will continue to monitor and respond to changes in air quality and temperature, but only using its quietest settings - and with its LCD screen dimmed.

If Auto purify mode or Auto humidify mode have been set, Night mode will reduce the airflow speed to a range from 1 to 4.

Personalize your Night mode settings in the Dyson Link app.

The remote control with the Night mode button on the right at the bottom.

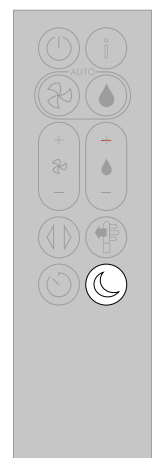

Deep cleaning your machine

To always get the best performance from your Dyson purifying humidifying fan, it is important to carry out regular deep cleaning to remove any mineral build-up.

Before and after long periods where humidification is not used, we recommend you run an additional Deep clean cycle.

In hard water areas you may need to run the Deep clean cycle more frequently. We recommend you use filtered water to always get the best performance from your machine.

Your machine will alert you when it needs you to carry out a Deep clean cycle.

If you are connected to the Dyson Link app, you will receive a notification message.

If you are not using the Dyson Link app, the LCD screen on your machine will alert you and the Deep clean cycle button will light up.

To cancel the Deep clean cycle at any point, press and hold the Deep clean cycle button for five seconds.

Keep the cap dry

Keep the cap on the water tank dry when you run a Deep clean cycle or fill the tank. It contains power connections and should not be washed. If wet, wipe thoroughly with a dry cloth. Make sure the cap and connections are completely dry before refitting.

Step 1

Remove the water tank

Press the Deep clean cycle button on the front of your machine and your instructions will be shown on the LCD screen.

Push down on the Outer cover release buttons to remove the outer covers. The inner door will spring open. Put the Outer covers to one side as you carry out the Deep clean cycle.

Push down the Water tank release buttons on the sides of your machine.

Slide the water tank out of your machine and unclip the cap.

Step 2

Remove the evaporator

Remove the evaporator from your machine, place it in the water tank and refit the cap.

The Deep clean cycle button can be located above the Standby button.

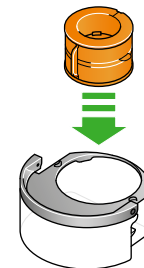
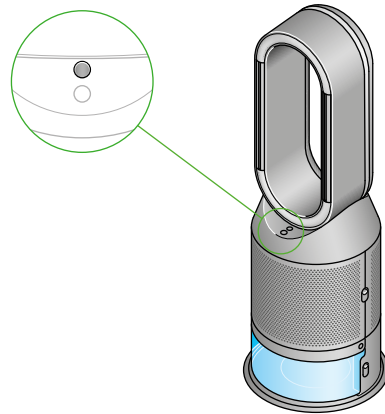

Step 3

Make a descaling solution

Carry the water tank by its handle to the tap.

Remove the cap and evaporator. Fill the water tank halfway to the Max level with cold tap water.

Measure out 150g of citric acid and place it in the water tank.

Agitate gently until all the citric acid has dissolved.

Place the evaporator in the water tank. Fill the water tank to the Max level with cold tap water.

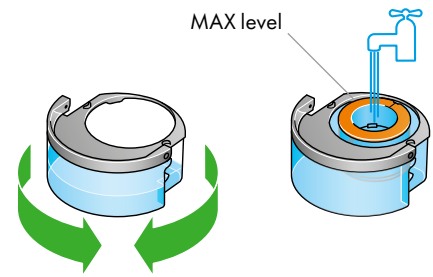
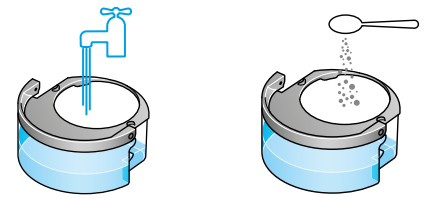

Step 4

Replace the cap

Replace the cap and secure the cap clips in place.

Wipe off any excess water to avoid drips.

Make sure the cap is completely dry. If wet, wipe thoroughly with a dry cloth.

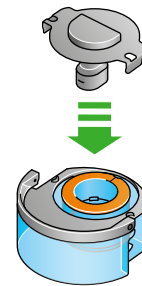

Step 5

Replace the tank

Slide the water tank back into your machine until it clicks securely in place.

When prompted by the LCD screen, press the Deep clean cycle button.

The Deep clean cycle will start and the LCD screen will show a countdown timer.

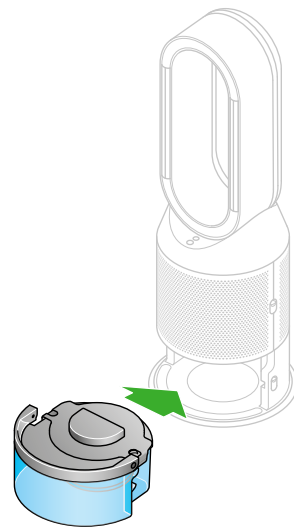

Step 6

Remove the water tank

When the LCD screen shows the Deep clean cycle is complete, push down the water tank release buttons on the sides of your machine.

Slide the water tank out of your machine. Carry the water tank by its handle to the tap.

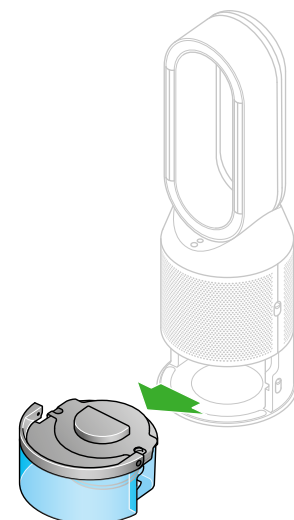

Step 7

Rinse

Unclip the cap, take the evaporator out of the water tank and rinse under a cold tap.

Wipe away any excess water to avoid drips and place the evaporator to one side.

Rinse the water tank under a cold tap. Wipe the inside of the tank to remove any excess solution and any debris.



Step 8

Refill

Refill the water tank to the Max level and wipe off any excess water and replace the cap, making sure that the cap clips are secured.

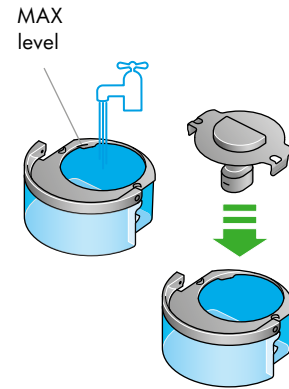

Step 9

Reassemble

Push the evaporator back into your machine, making sure that it is securely in position.

Close the inner door and replace the outer covers.

Make sure the cap is completely dry. If wet, wipe thoroughly with a dry cloth.

Slide the water tank back into your machine and make sure it is securely in place.

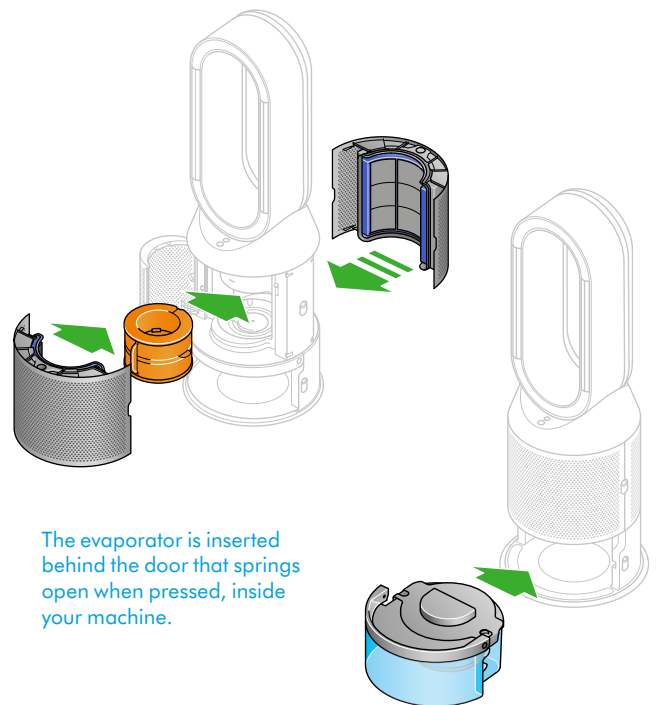

Changing your HEPA+Carbon filter

Supplied with a HEPA+Carbon filter.

To change your HEPA+Carbon filter, push down on the buttons either side of your machine to release the outer cover. Push down on the tabs to remove the filter.

Push the replacement filter into the outer cover and make sure the tabs click into place.

Put the outer covers into position on your machine and push firmly until they both click securely into position.

Plug in and switch your machine, and reset your filter life.

The purifying humidifying fan with the filter covers open showing a HEPA plus carbon filter located in the filter covers and a catalytic filter. Arrows demonstrate that the catalytic filter is fitted directly to the base of the machine and the filter covers will need to be assembled onto the base of the machine.

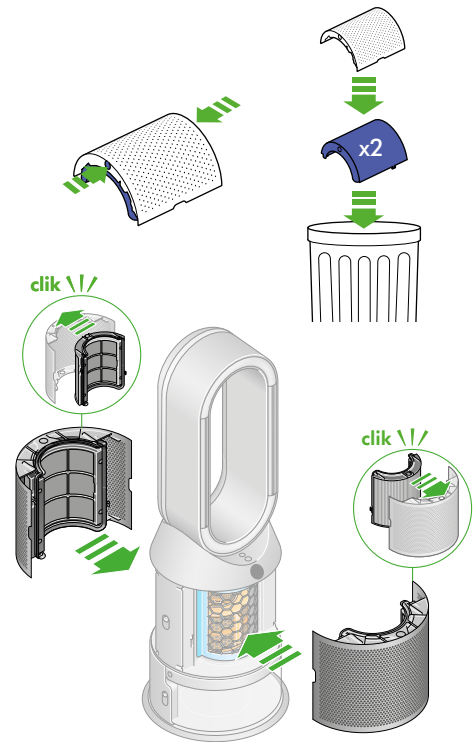

Resetting your filter life

It's important to reset your filter life after you have replaced your filter.

Press and hold the Night mode button on the remote control.

The LCD screen on your machine will count down from five, ending with default screen.

The filter life has been reset and your machine is ready to use.

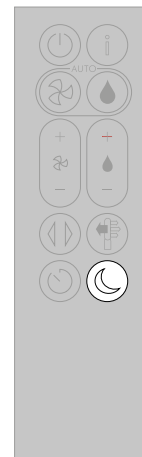

5, 4, 3, 2, 1...

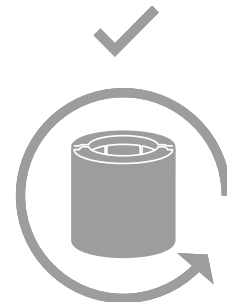

Looking after your machine

To always get the best performance from your Dyson purifying fan, it's important to regularly clean it and check for blockages.

Cleaning your machine

If your machine is dusty, wipe with a damp lint-free cloth.

Look for blockages in the air inlet holes on the filter and the small aperture inside the loop amplifier.

Use a soft brush to remove dust and debris.

Don't use detergents or polishes to clean your machine.

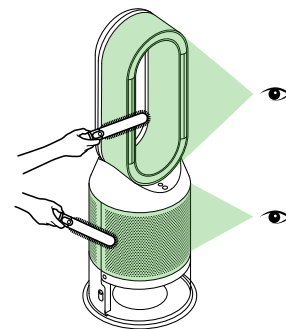

Alerts

Continuous alert icon

Switch off and unplug your machine.

Leave for 10 seconds and then plug your machine back in and switch it on.

If the alert icon continues to show on the LCD screen, contact Dyson.



Temporary alert icon

If the alert appears on the LCD screen and then disappears, continue to use your machine.

If any other alert icons show on the LCD screen, contact Dyson for further advice.