

## TECHNICAL SPECIFICATION

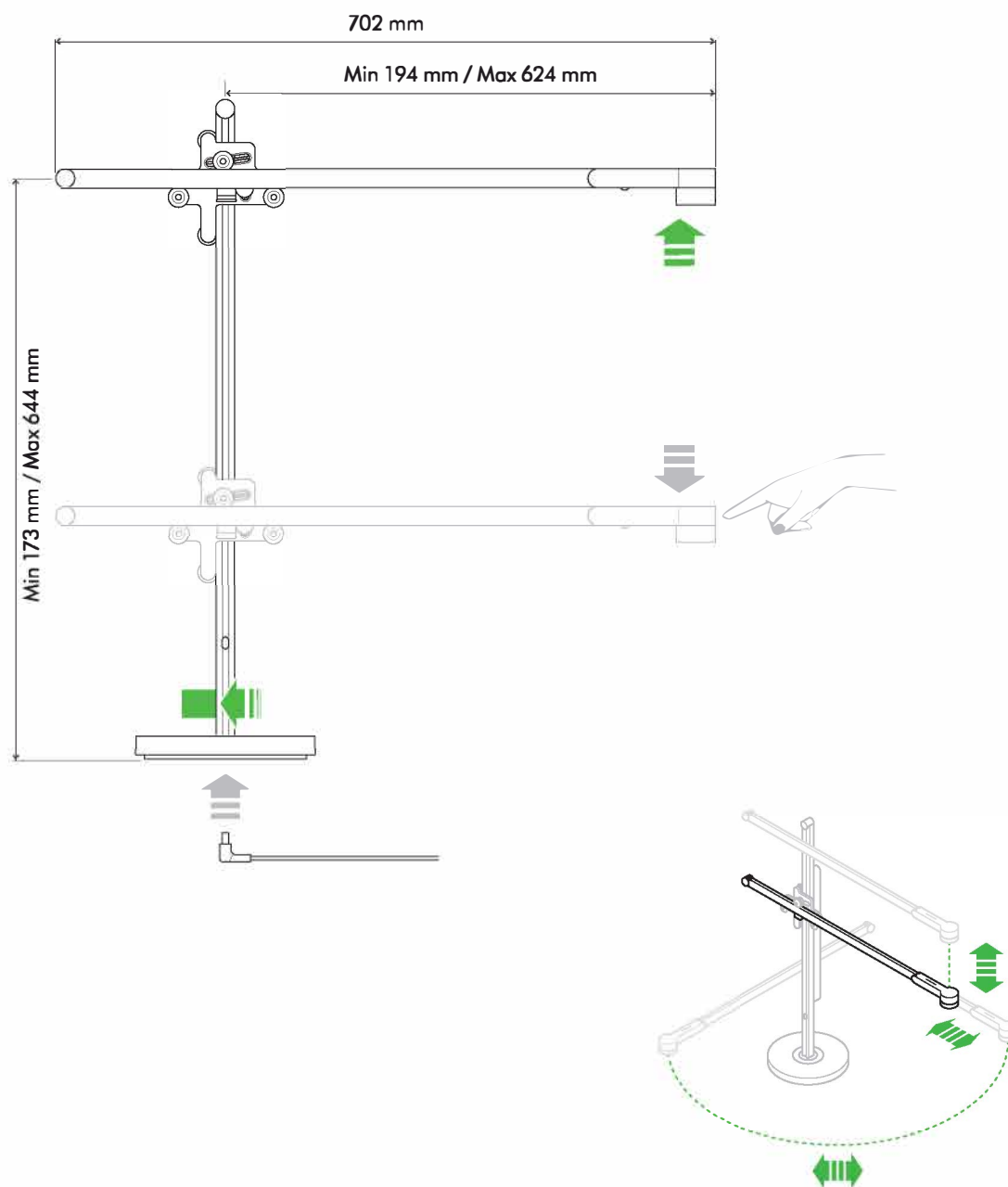

FRONT ELEVATION

SIDE ELEVATION



### Dimensions with arm not extended

Height 703 mm Width 702 mm Depth 190 mm

# dyson lightcycle desk

## Electrical

Input voltage / Frequency: 100-240V 50/60Hz

Rated power: 15.8W

Power supply cord length: 3.2m

Electrical class: Class III

## Optical

Light source: LED

Light output: 1120lm

Light output ratio: 82.1%

Luminous efficacy: 71lm/w

LED life time: 181,000 hours<sup>1</sup>

Colour temperature: 2700K – 6500K

CRI: 90 MIN

R9: 48 MIN

Standby power consumption: <0.5W

Beam angle: 78 degrees

IP rating: Indoor use only

Operating temperature range: 0°-40°C, 32°- 104°F

Flicker: <1%

Average lux level at full height, extension and max output  
(at 630 mm over 800 mm diameter area): 1194lx

## Features

USB-C charging point: 1.2A at 5V

Bluetooth® wireless technology

## Construction

Materials: Aluminium / Copper / Steel / Polycarbonate Plastic

## Operation

Precision dimming

## Logistics

Net weight: 4.09kg

Packaged weight: 5.65kg

Packaged dimensions: 282.5 mm (L) x 99.5 mm (W) x 809 mm (H)

## Accreditation

Complies with

UL 153

CSA C22.2#250.4

IEC/EN 60598-1, IEC/EN 60598-2-4

AS/NZS 60598.1, AS/NZS 60598.2.4

GB 7000.1; GB7000.204; GB4943.1

IEC 60598-1, IEC 60598-2-4

IEC60598-1, IEC 60598-2-4

## Standard warranty

5 years parts and labour

## Polar plot

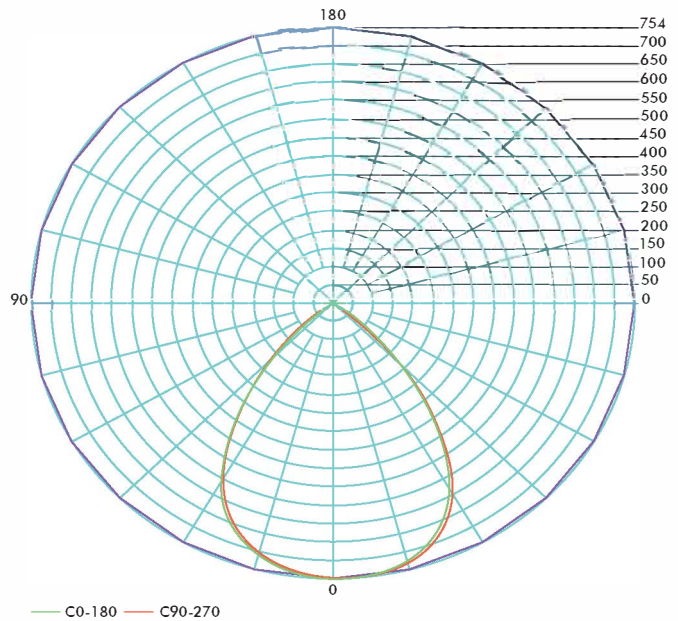

## Product range

White/Silver

Black/Black



<sup>1</sup>LED-life calculation is based on L70 measurement according to IEC, with an estimation of 8 hours' usage per day. Real-life results may vary.

## TECHNICAL SPECIFICATION



FRONT ELEVATION

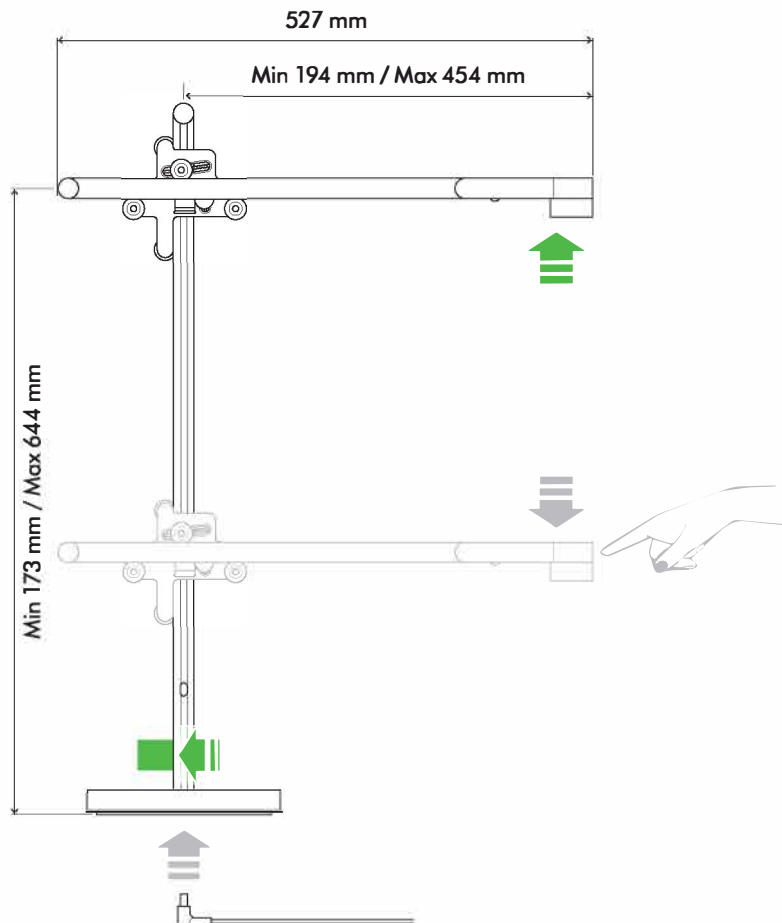

SIDE ELEVATION

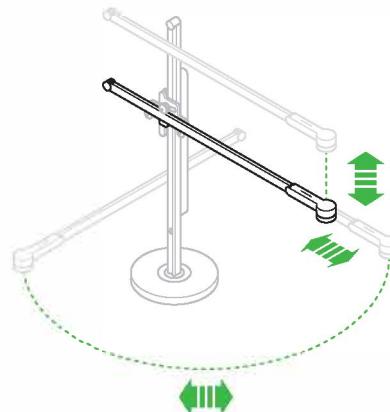
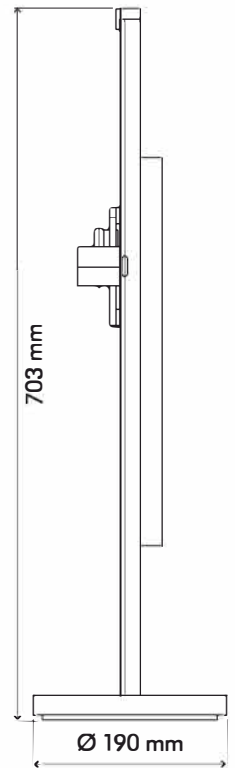

**Dimensions with arm not extended**

Height 703 mm Width 527 mm Depth 190 mm

# dyson lightcycle desk

## Electrical

Input voltage / Frequency: 100-240V 50/60Hz

Rated power: 15.8W

Power supply cord length: 3.2m

Electrical class: Class III

## Optical

Light source: LED

Light output: 1120lm

Light output ratio: 82.1%

Luminous efficacy: 71lm/w

LED life time: 181,000 hours<sup>1</sup>

Colour temperature: 2700K – 6500K

CRI: 90 MIN

R9: 48 MIN

Standby power consumption: <0.5W

Beam angle: 78 degrees

IP rating: Indoor use only

Operating temperature range: 0°-40°C, 32°-104°F

Flicker: <1%

Average lux level at full height, extension and max output  
(at 630 mm over 800 mm diameter area): 1194lx

## Features

USB-C charging point: 1.2A at 5V

Bluetooth® wireless technology

## Construction

Materials: Aluminium / Copper / Steel / Polycarbonate Plastic

## Operation

Precision dimming

## Logistics

Net weight: 4.13kg

Packaged weight: 5.69kg

Packaged dimensions: 282.5 mm (L) x 99.5 mm(W) x 809 mm (H)

## Accreditation

Complies with  
UL 153

CSA C22.2#250.4

IEC/EN 60598-1, IEC/EN 60598-2-4

AS/NZS 60598.1, AS/NZS 60598.2.4

GB 7000.1; GB7000.204; GB4943.1

IEC 60598-1, IEC 60598-2-4

IEC60598-1, IEC 60598-2-4

## Standard warranty

5 years parts and labour

## Polar plot

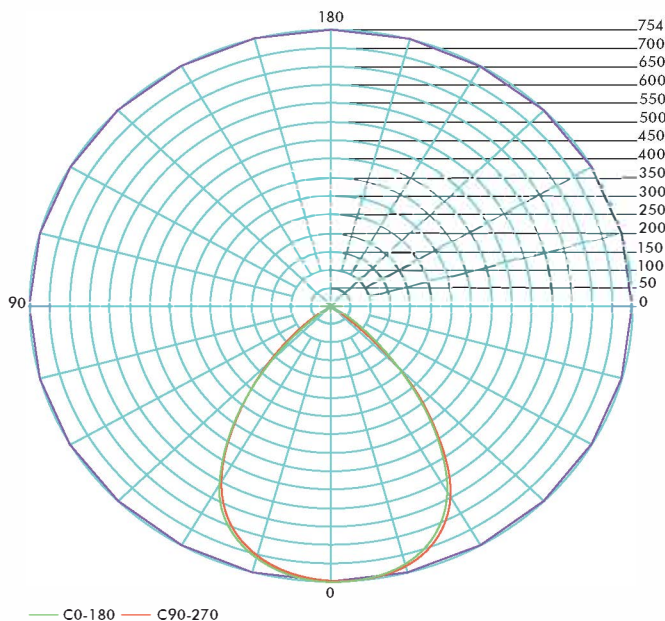

## Product range

White/Silver

Black/Black



<sup>1</sup>LED-life calculation is based on L70 measurement according to IEC, with an estimation of 8 hours' usage per day. Real-life results may vary.

## TECHNICAL SPECIFICATION



FRONT ELEVATION

SIDE ELEVATION

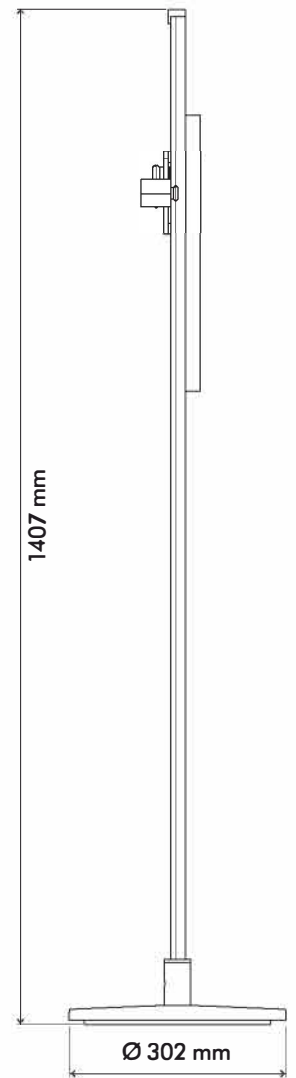
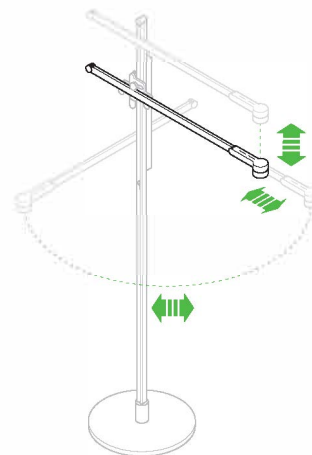
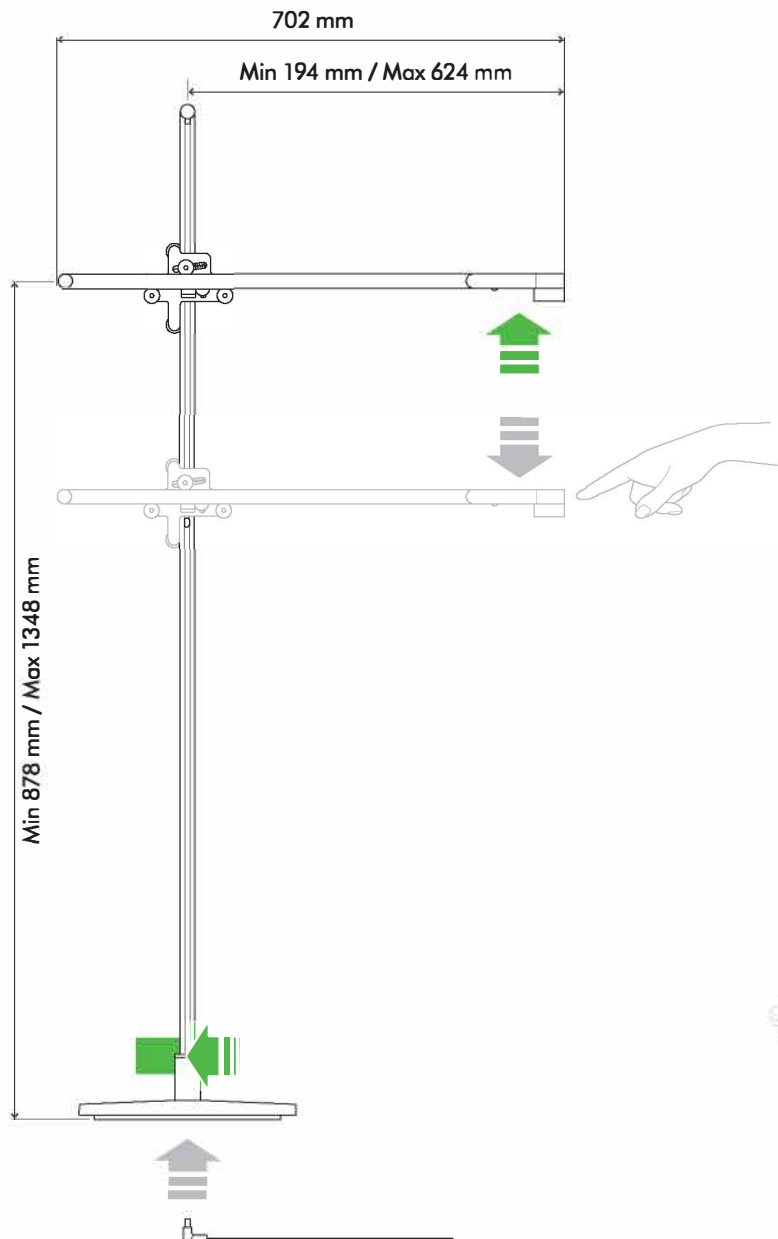

**Dimensions with arm not extended**

Height 1407 mm Width 702 mm Depth 302 mm

# dyson lightcycle floor

## Electrical

Input voltage / Frequency: 100-240V 50/60Hz

Rated power: 15.8W

Power supply cord length: 3.2m

Electrical class: Class III

## Optical

Light source: LED

Light output: 1120lm

Light output ratio: 82.1%

Luminous efficacy: 71lm/w

LED life time: 181,000 hours<sup>1</sup>

Colour temperature: 2700K – 6500K

CRI: 90 MIN

R9: 48 MIN

Standby power consumption: <0.5W

Beam angle: 78 degrees

IP rating: Indoor use only

Operating temperature range: 0°-40°C, 32°-104°F

Flicker: <1%

Average lux level at full height, extension and max output  
(at 630 mm over 800 mm diameter area): 1194lx

## Features

USB-C charging point: 1.2A at 5V

Bluetooth® wireless technology

## Construction

Materials: Aluminium / Copper / Steel / Polycarbonate Plastic

## Operation

Precision dimming

## Logistics

Net weight: 7.21kg

Packaged weight: 10.35kg

Packaged dimensions: 1487 mm (L) x 317 mm (W) x 112 mm (H)

## Accreditation

Complies with

UL 153

CSA C22.2#250.4

IEC/EN 60598-1, IEC/EN 60598-2-4

AS/NZS 60598.1, AS/NZS 60598.2.4

GB 7000.1; GB7000.204; GB4943.1

IEC 60598-1, IEC 60598-2-4

IEC60598-1, IEC 60598-2-4

## Standard warranty

5 years parts and labour

## Polar plot

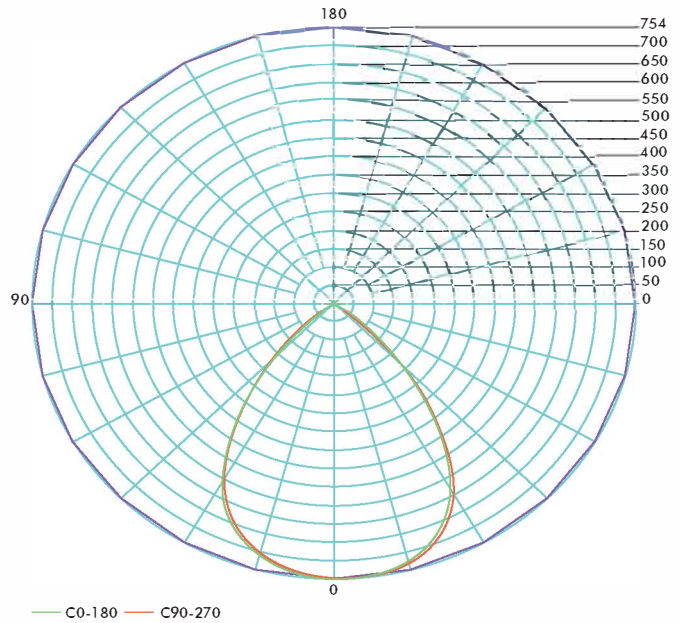

## Product range

White/Silver

Black/Black

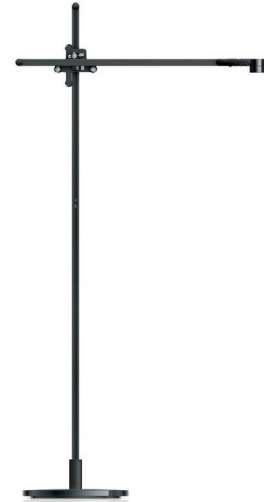

<sup>1</sup>LED-life calculation is based on L70 measurement according to IEC, with an estimation of 8 hours' usage per day. Real-life results may vary.